



Members of



Video Powered By



Remote Access Powered By

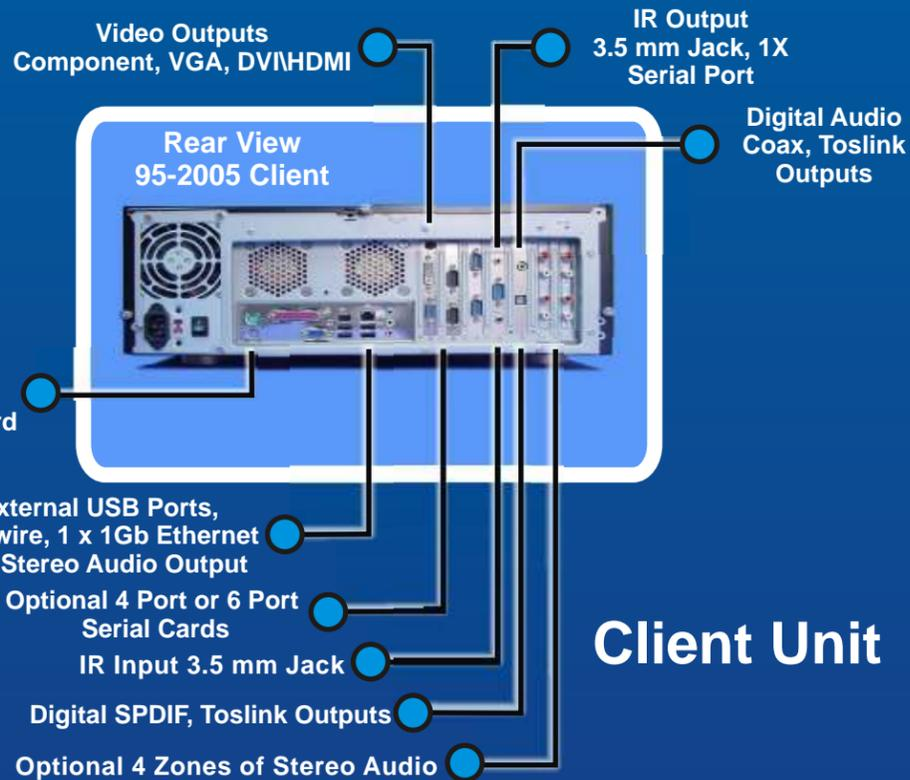

Client Unit

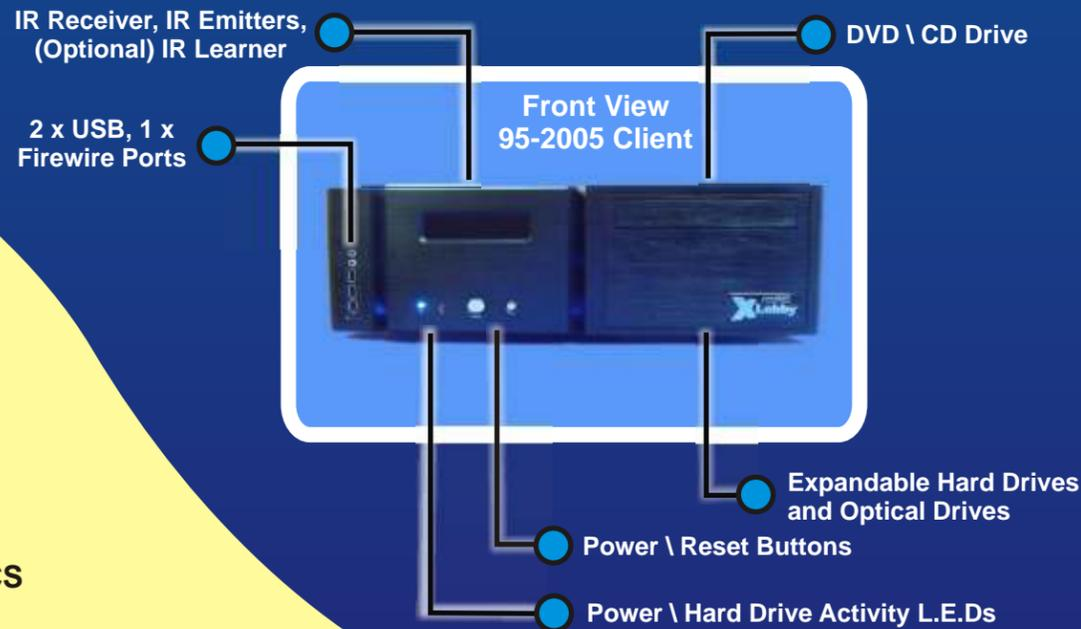

Distributed By:

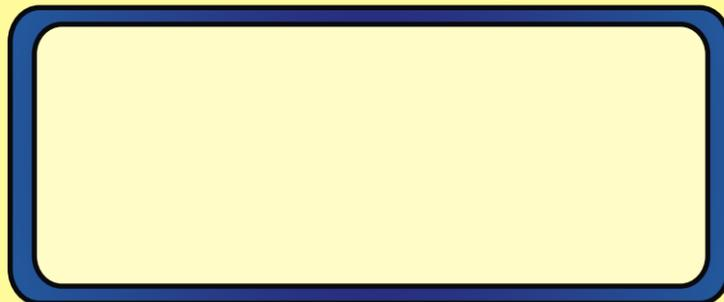

Product Brochure 2008



Media Management And Home Automation Your Way.....



- Security
- Russound
- CCTV
- HVAC
- Weather
- Videos
- Pictures
- Music
- Movies
- IP Radio
- News
- Lighting
- RS232

xLobby Partners

- Aurora Multimedia
- ELK Products
- Global Cache
- Infinity CCTV
- Insteon
- KNX
- PulseWorx UPB-PCS
- Russound
- Visionary Solutions

ROHS Compliant Products



819 N. Highland Ave.
 Los Angeles, Ca 90038
 Tel: 323-465-2131
 Fax: 323-465-3504
 Websites:
www.calrad.com
www.xlobby.com

Copyright Calrad Electronics 2008





Control & Automate Lighting, Security, HVAC and Home Theater all from one simple interface system

Introducing xLobby

xLobby becomes the nucleus for controlling and managing each piece of digital content in your entertainment system, including music, movies, videos, and photos, as well as home theater control and home automation systems. Whether you are using a stand-alone system or server-based system with multiple clients attached, xLobby makes your life easier. It provides easy access to media content, enabling you to watch and listen to any content from multiple locations. Whatever your system requirements are, xLobby is your digital control system solution. xLobby's intuitive design and control interface provides several ways to interact with the menu system. You can access your digital content and control system using IR Remote Controls, Touchscreens, Mouse and Keyboard, or send xLobby external RS232 commands and IP-UDP protocols from anywhere, over the internet. xLobby's menu-driven system also has PIN access features, so that any module or function can be password protected, providing secure access to adult content or critical system functions. xLobby is completely customizable for stand-alone or multi-room systems.

Using xLobby's powerful back-end software, you can control other external devices by RS232, IR or IP-UDP (User Defined Protocols). xLobby's powerful logic-driven interface can create simple one-button actions or linked-event macros with multiple triggers and timers. If needed, even more complex solutions are accessible, using boolean logic commands. Use xLobby's configuration & setup system for easy setup and configuration; and its built-in skin editor and unique design system can power xLobby's user interface virtually any way you want. The software makes it easy to create, build, and configure each system to your specific needs. The extensive design tools and graphics library provide simple access to change or re-design the default skin to suit individual needs, allowing you to brand your own interface or to define your own layout for each installation. The xLobby interface and video content will always perform to current video technology specifications because xLobby's unique graphic card solution can output video in both HDTV and VGA formats, providing simultaneous outputs for content to HDTV displays as well as VGA to touch screens for control.

Here are some benefits of using xLobby technology

- User interface supports IR Remote controls, Touchscreens, Wireless Mouse & Keyboards
- The system is designed to be easily ungradable when new technology is available
- Enjoy digital entertainment in a single easy to use system
- Access more entertainment with less effort
- Save space in your entertainment cabinet
- Experience all your digital memories with friends and family
- Put all your music at your fingertips
- Connect with online content for movies, music, and more on demand
- Built-In Skin editor for complete creative control of the interface
- Ability to define and constantly re-define the user experience
- Watch a movie or different movies from the system at the same time in different rooms
- Create and build individual or group Playlists for Music, Video's, Movies
- Create system events based on any command in the interface
- xLobby can interface to other 3rd party control systems such as AMX, Crestron, Control 4, Escient
- Works with RS232 and IP based interface equipment
- System wide interface linking for Music, Movies, Lighting HVAC

With xLobby in place you can feel confident today and tomorrow knowing that your system can always control your digital home environment using xLobby technology. Calrad strives to make your experience with xLobby a pleasurable one and to help user's maximize the enjoyment from all there media products. We will continue to add user driven features and to provide new services and media partners in the future to make xLobby your number one media centric product.

Calrad Electronics



xLobby Hi-Def Interface and Graphics

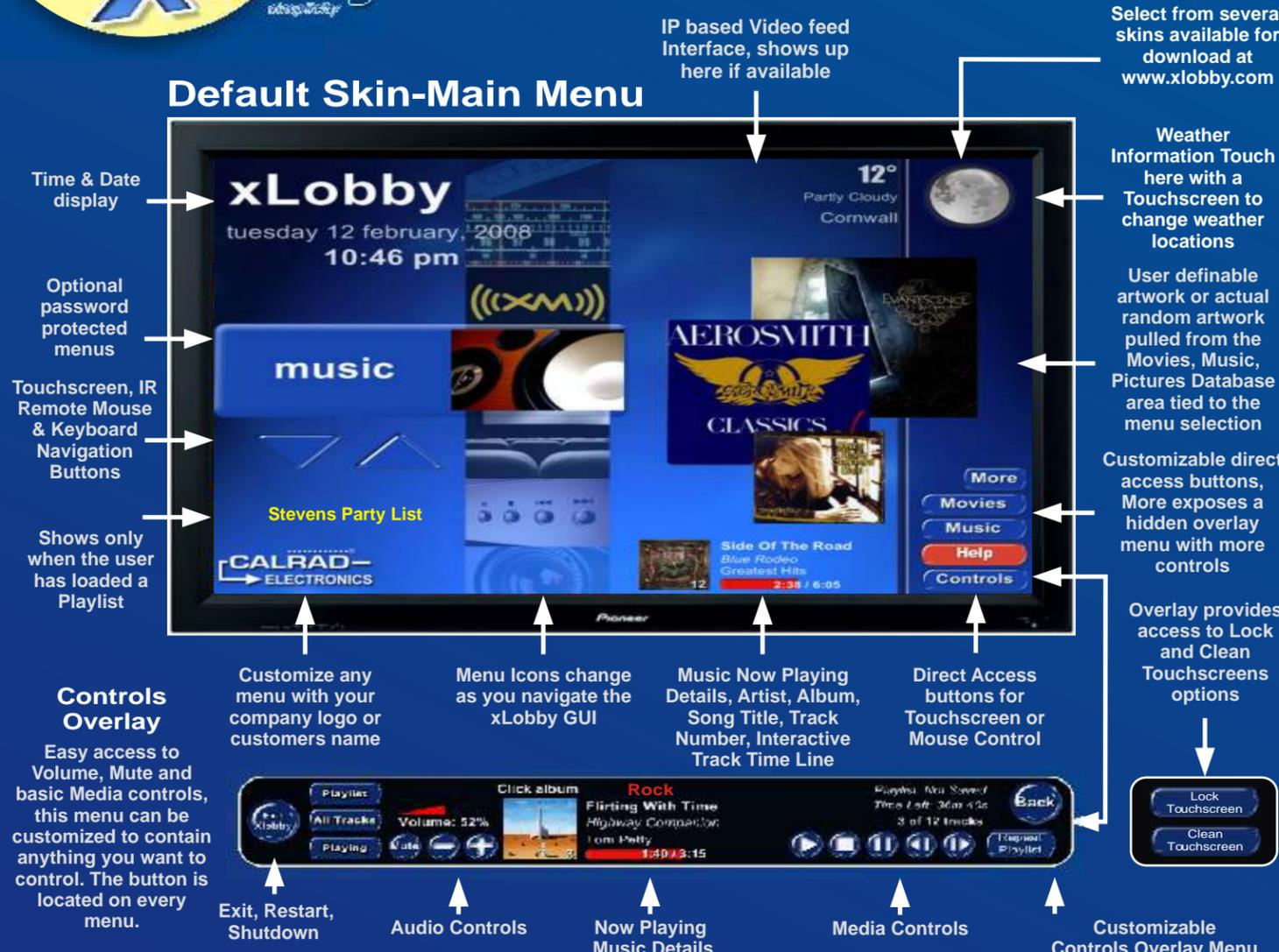

xLobby provides all the tools necessary to modify create and design any style interface you want, with all the controllability you need. The interface can be simple or as complex as your installation dictates or evolve as your design requirements change. The complete interface development tools and structure of xLobbys skin editor are built-in to the software for quick and easy access from anywhere in the system, we call this a Run Time Skin Editor. You can simply drag & drop or select items to create new Buttons, Images Backgrounds and have full control over there initial size or scale up or down in size, move, rename, re-assign different commands to them, all on the fly in real time.

Main Menus items on the default skin can be hidden or shown as well as password protected, this provides each user with access to content they want to navigate to as well as eliminates any content or menu's that are not important to them. xLobby is preloaded with a extensive graphic image and button library for creating different skins, even transparent overlay menus. A pop up Help balloon system is available to assist users in the setup and design tools environment when needed.

We make adding the same features to different menus as easy as copy & paste. If you want to create your own menu with different items and or functions, you can build them from scratch or copy them from other menus in the system. The internal setup menu provides access to all the controllability of xLobby as well as building and creating the logic that goes behind the interface for menu's, buttons and graphic imagery. The flow of how xLobby navigation of menu's and buttons interact can also be configured.

xLobby can provide different levels of control for content management from 1 client to multiple clients, server installations to whole home automation. Careful consideration of each system to operate alone or together is what makes xLobby unique, by providing an integrated control system from one interface users can jump from a music menu or from playback of a movie right into a menu that controls the lighting system or to looking at the security cameras. The ability of xLobby to control external devices using standard RS232, IR or IP protocol commands enables the system to communicate with virtually any device.



xLobby Setup Menu

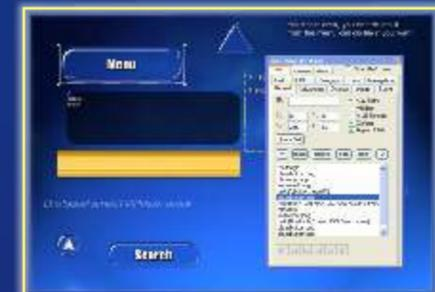

xLobby Skin Editor

Music Layout Menu



The Music Overlay menu provides users with 5 options to view music. Generic, Prism, Flow, Ambience, Playlist. Each interface has certain features and benefits for navigating, playing music, creating playlists. The overlay skin can be modified to suit individual users needs or requirements.

Music Filter Menu



The Music Filter Overlay menu provides a simple method of sorting music by 1. Artist, 2. Albums, 3. Songs, 4. Genre, 5. Year. A reset function will reset the database view back to Artist by default. Create your own filters, for example by users, favorites, etc. .

Music Search Menu



The Music Search Overlay menu provides searches based on the Music filter settings. This menu provides access to the Music Filter menu for quick searching of your content.

Generic Music Menu



The Generic music menu provides a simple CD cover view of your music with cover artwork set as default, navigation can be configured to be a list view by Artist, Album, Genre, Song Title, Year. The artwork displayed per page can be increased or decreased using the (+), (-) buttons, the artwork quantity per page is displayed for reference. A search button is provided for searching by Artist, Album, Genre, Title Name, Year, Date loaded into xLobby. This module is also used to create music playlist's, xlobby provides a navigatable icon driven view of what songs have been added to the playlist.

Flow Music Menu



The Flow music menu represents a more graphical representation of CD cover artwork providing the user with a more visual navigation style interface. Easy to navigate with a hand held remote control or by the Touch screen friendly graphics, touching the cover artwork on the right side of the artist in the middle to move forward and the cover artwork on the left to move backwards, selecting the cover artwork in the middle will start playing the artist. Touching or selecting the now playing cover artwork will bring up the track list for that artist. Using the jump button provides a keyboard overlay to directly access artists by name.

Prism Music Menu



The Prism menu provides a in depth snapshot list style view with coverartwork of the music library, jump directly to your music by Artist, Album, Song Title, Genre, Year format style with expanded views, groups music by Artist, Album, Year all the details are represented on one screen. Search by Artist, Album, Song Title, Genre, Year.

Playlist Music Menu



The Playlist menu provides the tools for creation of custom playlists, a list view interface for managing songs and the order in which they will play or deleting un-desired tracks. The playlist displays the track title and time as well as the artist and album. Playlists can be added to other playlists to create different listening experiences. A shuffle button further insures a mixture of different types of music. The Playlist Stats will show a complete overview of the total tracks and total play time.



It's Movie Night

What do you want to watch !
Easily sort through your entire Video Library using Cover Art Navigation and In-Depth Program Information



Movie Category Menu



Default Movie



Movie Spider Overlay



Imagine being able to access all your movies from one room, or several rooms in your home, without spending valuable time trying to locate the title you want. This can be done with xLobby's media content management system; find movies by title, rating, year, actor, or director, and/or create your own custom search tags. The movie management menu displays movies in cover artwork format. The artwork displayed per page can be increased or decreased using the (+) or (-) buttons, allowing the user to set the amount of titles shown per page. The artwork quantity per page demonstrates how many titles fit on a page, but xLobby's interface is fully customizable, so you can view movies by text or any other graphics style. Using the jump button opens a keyboard overlay that provides quick access to locate movie titles alphabetically. Each time a "Movie" is selected, the title details and synopsis are shown in the preview window, as well as the playback overlay menu. Movie title details are available thru xLobby's online spider system which obtains DVD artwork and movie title information. The xLobby Movie databases can consist of 5 categories or separate Movie libraries: Movies, Family Home Videos, Music Videos and Adult Material. Each movie database can be password protected, if needed.

DVD Disc Found Menu



Inserting a DVD into the tray will bring up xLobby's DVD Disc Found menu. There are several options presented: 1) Play (play back any DVD in the system DVD tray); 2) Select Copy (then select the category you want the movie to go into and this will copy the DVD into the system); 3. Close (this will close the DVD Disc Found overlay menu).

DVD Importer Title



This menu is step 1 in the DVD Importing process. xLobby can add the title for you automatically, or you may enter the title of your movie manually, using a standard keyboard or xLobby's on-screen keyboard. xLobby will use this title to display and organize your Movie content.

DVD Importer Options



Step 2 of 2 has two menu selections: 1) Copy Main Movie (copies only the movie title, along with trailers or other extras; and 2) Copy Full Disc (with all the content 1:1).

Average Movie Copy Time 6-8 Minutes,
Typical Space required per Movie is 5-7Gb

DVD Importer



This DVD Importer Progress menu displays total time elapsed, task time elapsed, task time, megabytes per second, and progress bar.

DVD Import



This DVD Import Successful will be shown if the copy process was 100% complete; if not, an error message will appear, indicating copy failure.



xLobby does not decrypt DVDs, but talks to 3rd party software to provide communication, information and updates on the copy process. Content can be on internal, external hard drives, or NAS based storage systems.

Media Player Menu



The Media Player provides playback of various video formats, simple navigation controls are easily visible for touch screen or IR remote controls.

Weather Menu



The weather menu provides a simple 5 day weather forecast with selectable detailed weather information and Satellite map imagery. Multiple weather locations are possible.

Lighting Menu



The Lighting Menu provides access to controlling lighting for multiple rooms or by Preset Lighting scenes, a visual image of the room can be attached to reference each zone.

RSS News Feed Menu

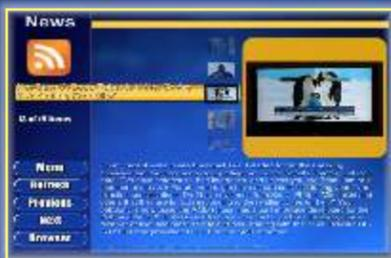

The RSS "Really Simple Syndication" News Menu delivers updated News content to specific user selected channels.

Webcams Menu



The Webcam's menu provides access to IP based camera's or IP encoders for security camera's.

Video Streams Menu



The Video Stream's Menu provides playback of internet based audio and video content. Browse feeds by channels.

Hardware Sample Menu



Design your own Hardware control interface Menu, RS232, IR, IP based control for A/V switchers and more.

Basic Help Menu



Design your own Help Menu interface Modify contact information, provide information to your customers regarding there system.

Web Browser Menu



The Web Browser provides access to the internet, view or add links to your favorite sites. Remote and Touch screen friendly.

You Create it and let xLobby Control it !

Receiver Control Interface



Sprinkler Control Interface



Security System Interface



Theater Control Interface



Russound Control Interface



Custom Interface



Audio - Video
HVAC
Lighting
Security
CCTV

Typical xLobby Installation

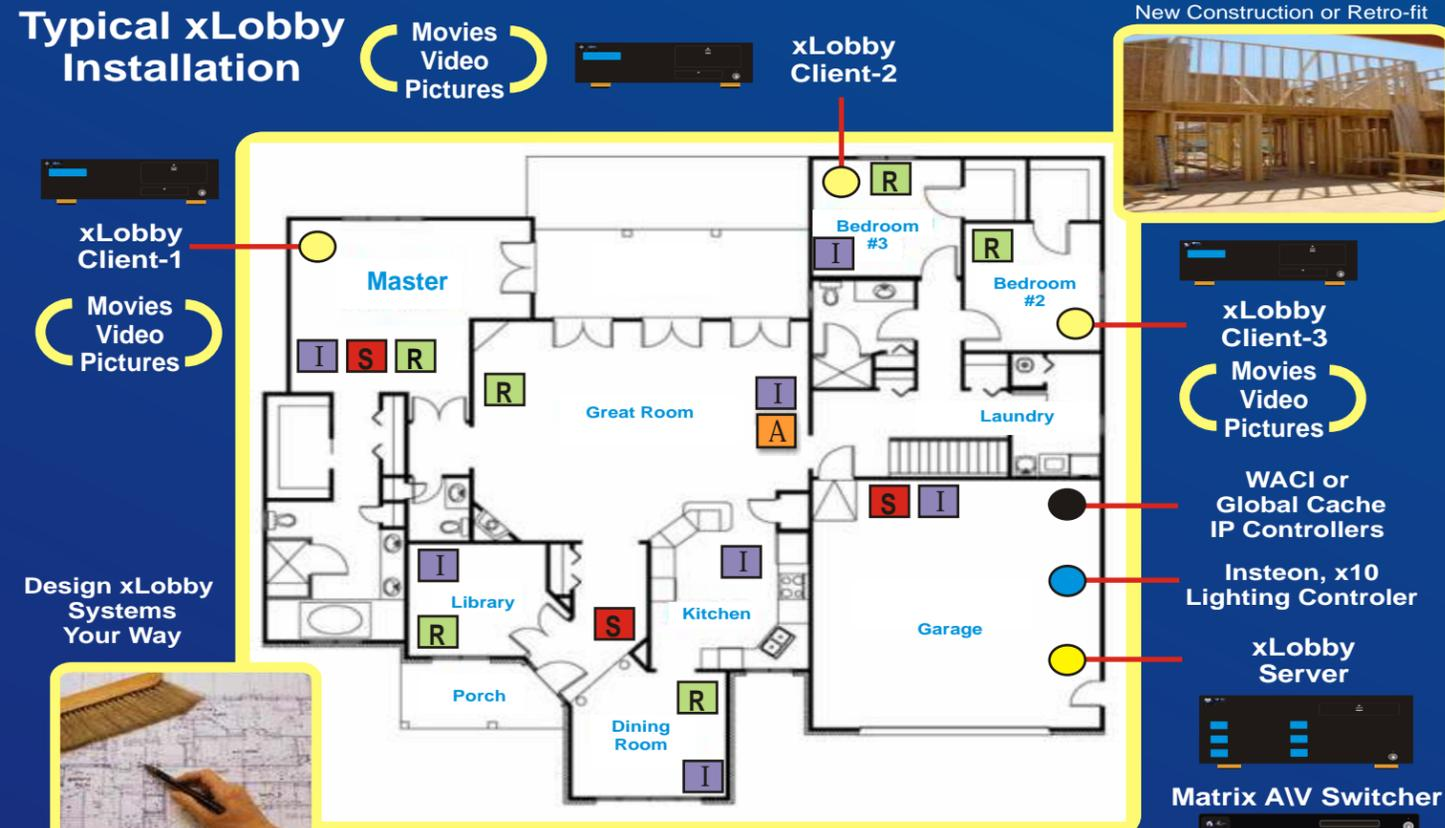

Design xLobby Systems Your Way



xLobby Resource Management and Intelligent Lighting



New Home Construction or retro-fit into Homes, xLobby works where you need it to, in dedicated home theater applications or whole home media and control environments. Smart and innovative products are a crucial part of creating and installing a media control system. It starts with a good understanding of your customers needs and requirements. xLobby can provide these solutions because the core of the system is designed to be open and flexible. xLobby can work with familiar products you currently use and install as well as other brand name devices in the industry, get creative and do-it the way you want. Out of the box support for Russound distributed audio, Insteon, UPB lighting, GE Security systems, Aprilaire Multi-Thermostat HVAC. xLobby's unique event driven control structure makes it possible to have media events interact with lighting and home automation events. Lighting or external sensors that can trigger any system wide event for customized set of macro's or calendar driven events to play music, video's or movie's, or to turn equipment on or off. xLobby is capable of playing multiple zones of audio and video. Video content can also be extended to area's with-out a xLobby media client devices by using video distribution amplifiers and video matrix switchers to send video to where it is needed.

xLobby Multi-Zone Audio

Multi-Zone Overlay Playing Independent Audio



Independent Music Zone controls for Volume, Mute, Artist-Track selections, Independent Playlists, Media Playback Controls, xLobby built-in code library Interfaces directly with Russound hardware via RS232, see Fig. 1 or xLobbys Internal \ External audio hardware see Fig. 2. Advanced features include 4 Zone Master Mute control, independent audio level governor, smart sync technology and optional password protection for each zone. Since xLobby can control standard or multi-button lighting switches, these same switches can become virtual keypads to do just about anything you want including a volume control, source control or audio video switching. Even multi-Zone keypads can control lighting. Remember with xLobby you can do almost anything!

Multi-Zone Overlay Playing Synced Audio



40-ZA1 Internal 20 Watt Stereo Amplifier Audio Card
40-ZA2 Stereo External Zone USB Audio Dongle
40-ZA4 Stereo Internal 4 Zone Audio Hardware



Full 2 Way RS232 Control

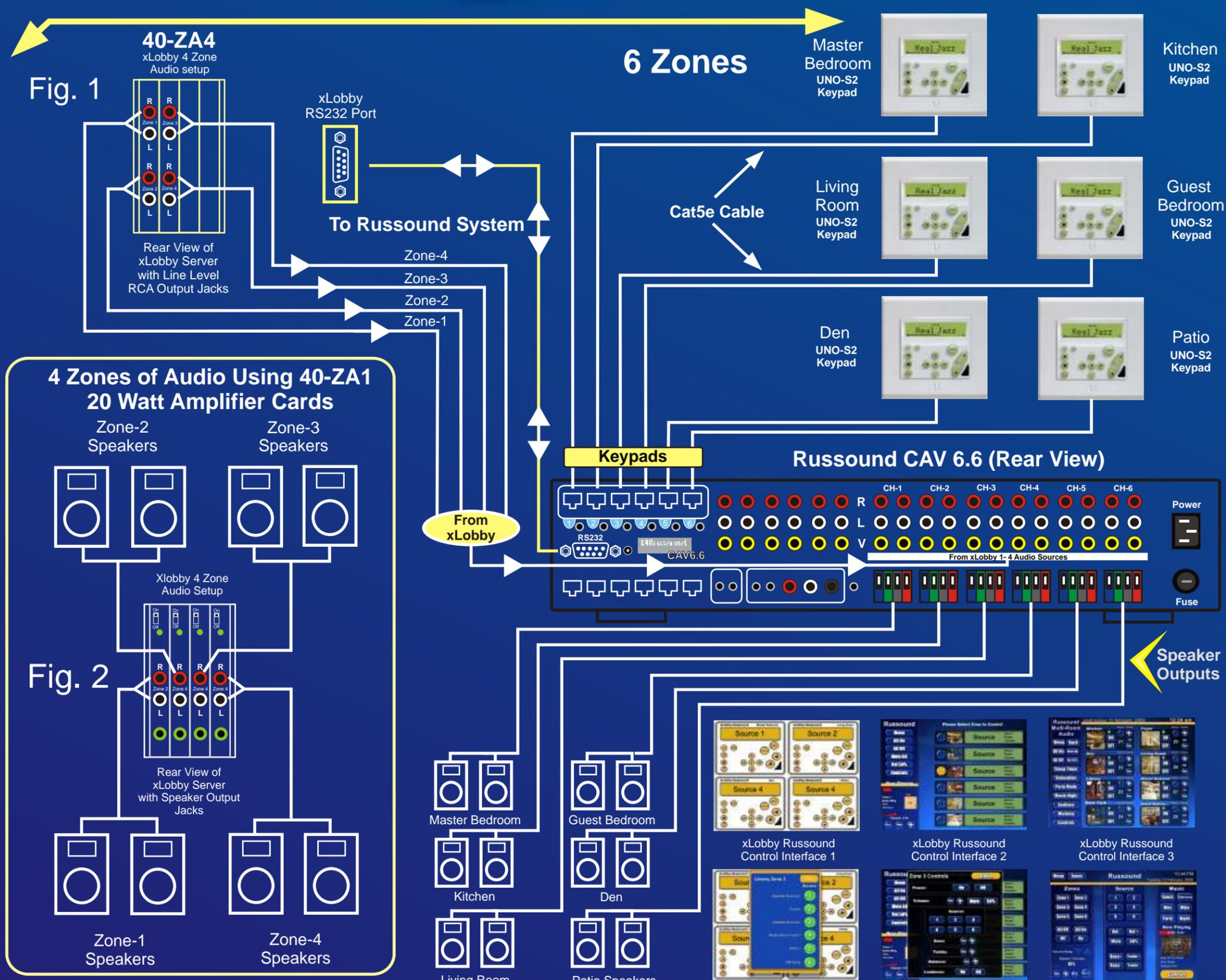

xLobby Multi-Room Lighting, HVAC



Basic Lighting Control Menus

Advanced Event Scheduling System

Under Current Development Product Support and Driver List

KNX Lutron Vantage HAI

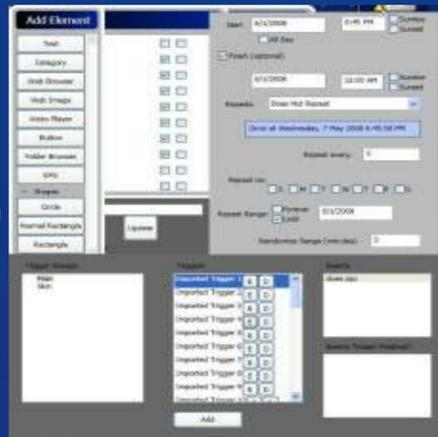

Control your lighting using a simple remote control or touch screens. Access individual lighting or appliance devices for each room by selecting on/off commands manually or by scheduling lighting events using xLobby's built-in scheduling features. Link lighting events to music, movie playback or any system event. Create custom lighting scenes manually or based on single or multiple dates and times.

xLobby Green

Save energy and money on bills by remotely controlling your thermostat and lighting systems, power strips or let xLobby manage and schedule devices in your home automatically to reduce un-necessary electrical power consumption.

KNX

Calrad is currently integrating additional lighting systems, as well as the KNX technology standard into xLobby – the world's only OPEN STANDARD for all applications in home and building control. Systems range from lighting and shutter control to security, heating, ventilation, air conditioning, monitoring, alarm, water control, energy management, metering household appliances, audio and lots more. The technology can be used in new, as well as existing homes and buildings. New products and possibilities will be available soon.

Insteon

What makes INSTEON the most reliable home automation technology is its dual-mesh network. The "dual" part of the network refers to INSTEON devices using both radio frequency signals and the home's existing electrical wiring to talk to each other. Every message is confirmed as it is received, and if any errors are detected, the message is automatically resent. INSTEON's "mesh" network has EVERY INSTEON DEVICE acting as a repeater -- receiving and sending every message to all other devices on the network. Instead of stressing the network by adding more INSTEON devices, you actually strengthen it.

UPB-PCS

Universal Powerline Bus (UPB™) is a highly reliable, cost effective 2-way communications technology which enables control products to utilize existing power lines for residential applications. PCS' powerline communication technology utilizes a PPM (Pulse Position Modulation) encoding/decoding method. The physical layer method is a very different scheme than the modulated/demodulated RF techniques used by other manufacturers. The results in reliable communications are greater than 99% accurate!



View lighting events by zone, status, groups, schedules or descriptions and images of rooms. Control exterior and interior lighting. Simple on and off and dimming preset commands.



xLobby can control and manage multiple types of interior or exterior lighting systems at the same time using existing electrical wiring. Calrad is currently offering several bundled technology packages that include lighting, Multi-Zone audio and AV control and automation. The basic concept is to create a complete system around the products you already use with xLobby pre-configured out of the box to work with minimal configuration and setup time. Each xLobby system can be different for each type of installation like system (A) is xLobby with Multi-Zone Audio, system (B) is xLobby with Multi-Zone Audio, Lighting, Irrigation, etc. . xLobby can bring together lighting elements controlled by or mixed with Music or Movie elements such as having the lighting dim to a certain preset when you start a movie or turn the lights back on when the movie is completed. Contact Calrad for more details.

Simple to install and use, no new wiring required uses existing electrical wiring to communicate with xLobby

xLobby Insteon Lighting Bundle



xLobby UPB Lighting Bundle



xLobby Client or Server



Other Insteon control modules and accessories are available, like multi-button wall switches, irrigation modules, appliance modules, multi-zone thermostats. Most devices available in White, Ivory, Black.



Other UPB accessories available, Input control module, Door bell interface module, Telephone Ring Module. Most wall switches and controllers available in six different colors: White, Almond, Ivory, Brown, Black and Grey to match practically any decor.

xLobby controlled L.E.D Accent Lighting Products



Insteon

RS232 or USB PLC Interface modules, these devices connect to xLobby hardware to communicate with any insteon device connected to the electrical system.



Full 2 Way Control

UPB

RS232 PIM Interface module connects to xLobby hardware to communicate with any UPB device connected to the electrical system.



Powerful Client Server Technology

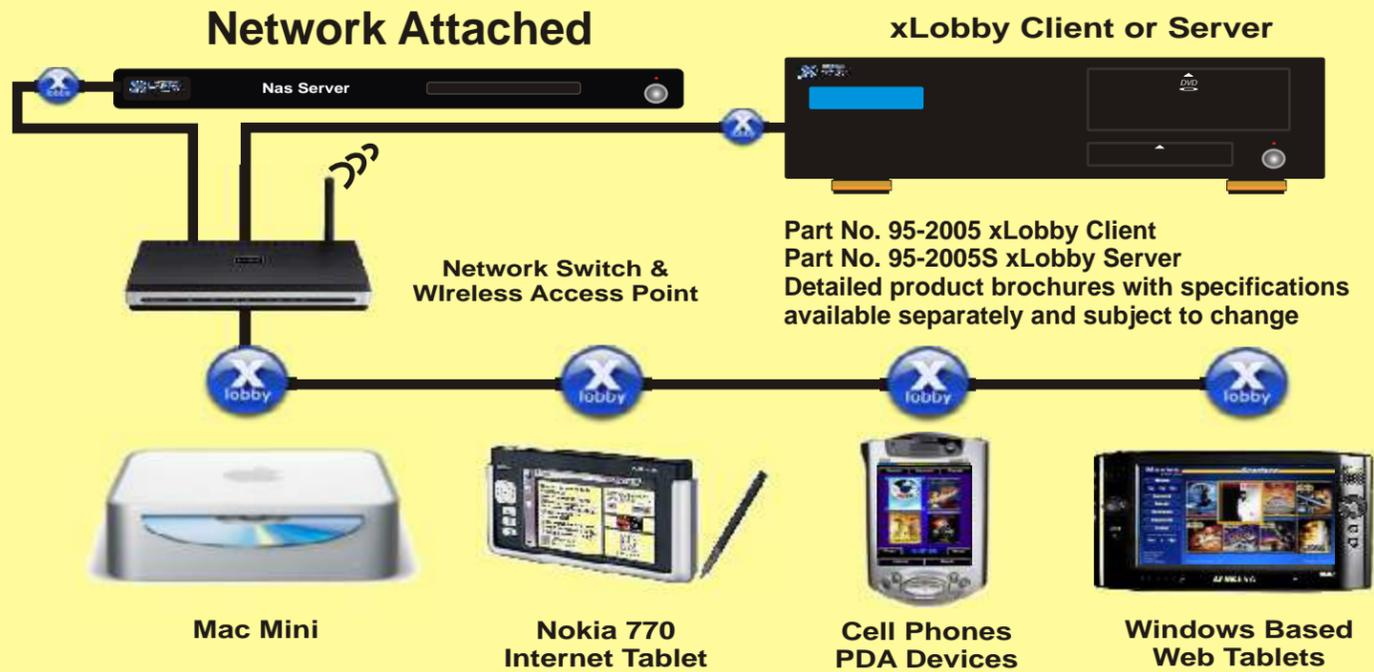

With xLobbys XNET Server or thin client application you can use virtually any Windows based or web enabled device to access xLobby on a 100Mb, 1Gb wired lan systems or 802.11 G, N wireless network for complete control of any device connected to xLobby.

xLobby NAS system (Network Attached Storage)

The xLobby 1Gb NAS system is a web based unix storage system for any type of data or media files. NAS devices offer high performance content management for streaming content to multiple xlobby clients. Clients can connect to any NAS device connected to the network to get Movie, Video, Music, Picture content.

Access to all your Music, Movies, Videos, Photos using external USB, Firewire or NAS drives



Bring xLobby with you Laptop's, Web Tablets, Mobile PC

Experience your media away from home. Play Movies, Music, Home Video's, Family picture's with slide show's anywhere you want. Log into xLobbys server via the web and access or control anything you want from outside your home. Use xLobbys RF remote control or your portable laptop.



xLobby IR Remote



xLobby-Pad RF Remote

IR or RF Style Remotes



Flexible Control Interface, Ease of use, Comfort & Convenience, Peace of Mind

Irrigation

xlobbys home irrigation control's can optimize watering schedules based upon weather forecasts and seasonal changes manually or by linking the controls to the internal weather module. Program Winter and Summer watering times and schedules. The xLobby hardware will work with any standard 24V AC sprinkler system. The built-in powerline interface stores your timed programs, so you won't need to worry xLobby will always be able to turn your sprinklers on and off at scheduled times.

Lighting

Create the perfect mood for a romantic evening with the simple push of a button. Just one command from a touch screen, in-wall event controller and you can dim the lights, turn on soft music, start the indoor water fountain or aroma lamp. With your imagination and xLobby, the possibilities are endless. xLobby lighting control provides ease of use, convenience, peace of mind.

Let xLobby automate the dawn/dusk controls do the thinking for you, your night and morning routines can automatically adjust for the changing times of sunrise and sunset throughout the year, so you won't have to worry about reprogramming your driveway lights or outside accent lights when it starts getting darker in the winter. Make your home look occupied while you're gone or on vacation, wake up each morning by scheduling your bed-side lamp or any other devices to turn on automatically. xLobby supports various lighting products like Insteon, UPB, X10, with new drivers for other manufactures being added on a regular basis.

Pool - Spa Automation

Control your Pool, Spa, Water Features, Water Fountains. Automatically turn the SPA on before you leave work so the water temperature is just right and your favorite music is playing when you get home.

Energy Management

xLobby can manage your homes Audio-Video Systems, Lighting, HVAC and other electronic devices to help minimize your electricity consumption.

Client Server Remote Control

Built-in Web Server for complete remote control access. Provide access for service people by turning off or on lighting, open gates, turn off the alarm system all from your office or anywhere in the world with internet connectivity.

Remote Log-In

xLobby use's Log-Me-In to Access & Control a xlobby client or server that's connected to the internet from anywhere in the world. Make remote service call's, update xLobby systems, Remote training for user's.

xLobby Speech

Available late 2008 early 2009. xLobby control systems will have integrated speech based technology available for voice control.

The Nucleus of your Home Control System



HVAC

Let xLobby modify your Heating and AC controlled comfort by fine tuning your thermostat schedules, so that your home's climate is in sync with your lifestyle. Indoor and outdoor sensors can provide readings and adjust the temperature automatically. Calendar based scheduling for weekdays, weekends, vacations or special events.

General Automation

No more fumbling with car keys in a dark driveway, you'll get out of the car and watch your lights come on all the way to your door and through to the hallway and living room. Come home to a cool house in the summer with fans that come on automatically an hour before you get home, or a well-lit front porch in the darker winter months. You can create customized home automation routines according to your schedule or your families schedule.

xLobby Includes calendar-based functions for easy scheduling of any system wide event as well as true 'trigger-based' automation with advanced conditional options.

Music Automation

As your moods change, so can the lighting. Synchronize table lamps, floor lamps, ceiling lights Multi-Colored L.E.D. accent lighting and wall sconces to create different moods in a room based on your preferences. When your reading, you may want an relaxing environment with the light next to your favorite chair fully on, while other lights in the room to be much dimmer. But at other times, you have guests over and would rather have a bright party atmosphere, playing your favorite music playlist. If your entertainment goes late into the night, you can change the mood into an after hours nightclub at home and play your music library Party playlist's.

Movie Automation

Play Individual or multiple Movies in any room using xLobby controlled RS232 HDTV video matrix switchers to route video feeds from xLobby client units to xLobby server units. Imagine at 8:00pm a reminder pops up on all the touch screens and monitors in your home to remind you of your family movie night, this can happen because xLobby can turn on any Plasma, LCD, DLP device in your system and route the appropriate video there.

Holiday Automation

Timed home automation routines are great for the holidays!, for Christmas set up your home automation system for amazing timed holiday lighting displays - you'll be the most impressive house on the block! or for Halloween create scary lighting scenes, control or animate scary creatures and sound effects.

Multi-Zone Audio

Home automation can link between any client or multi-zone audio controller to provide additional lighting control or any other function's you want. Music Zones linked to xLobby can command any xLobby system event.



xLobby 95-1074TSR Zigbee Touch Screen Universal Remote



xLobby 95-1062 Series 10.4" Touch Screens



Use RF or IR Keyboard & Mouse

xLobby Controls what you want when you want

xLobby use's various devices to provide efficient routing of control, Audio - Video signals required for touch screens, media servers and client's. IP based controllers provide access to manage devices using existing home network systems. Individual product brochures are available for all items shown upon request.



95-1062-BK (Black 10.4")
95-1062-WH(White 10.4")
95-1061-BK (Black 8")

Desk top Touchscreens available in USB or RS232. Detailed spec. sheets available upon request. In wall installation kits. 10.4" screen size part number 95-1062-IWK, 8" screen size part number 95-1061-IWK.



40-KM01
 Passive Keyboard & Mouse Over Cat 5e, up to 300 ft.



40-UE04H-1
 Powered 4 Port USB Over Cat 5e, up to 150 ft.



72-130
 RS232 Over Cat 5e Adapters, distance's up to over 200 ft.



40-WACI
 IP Based Network Adapter, 4 x IR, 2 x RS232, DSP, 4 x Relay controller



95-1070
 USB external IR receiver dongle with remote control



95-1071
 USB external RF receiver dongle with remote control



95-14074TSR
 Zigbee-IR Wireless Touchscreen Universal Remote with 4 x Discrete IR outputs, 1 x RS232



72-140
 Ethernet over AC up to 14mbps bandwidth 2 devices required



40-GC-100-12
 IP Based Network Adapter, 6 x IR, 3 x RS232, 3 x Relay controller



40-6110, Single Channel
40-6210 Dual Channel
 VGA or HDTV Component + Stereo, Digital Audio Balun's. All over a single Cat5e UTP cable

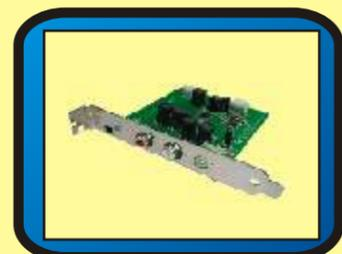

40-ZA1
 xLobby 20 Watt Class 'D' USB Zone Audio Cards. xLobby can use up to 4 cards

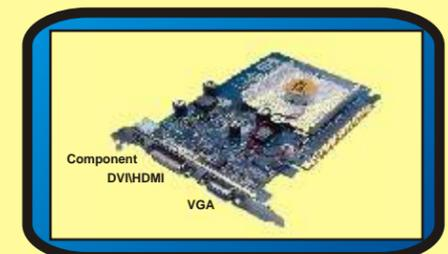

40-S3
 Dual output HDTV, VGA Graphics Card, xLobby is driven exclusively by S3 technology, 256Mb memory, uses 1 PCI-Express slot

xlobby Features

Advanced

- Client Server, xNet engine
- IP Based Streaming Media (Audio-Video) Multi-format tag mask importer
- Includes calendar-based functions and event management for easy scheduling
- Audio Mixer
- Remote Log-in software
- PIN security by Menu, Setup, Skin Editor

Back End \ Interface Support

- Built-in Skin Editor
- Setup Menu System
- Software Plugin Support
- Choice of 3 pre-installed themes
- On-screen configuration
- Serial & IR libraries
- User configurable Help System

Client Server Support

- Built-in Web Server for remote xLobby access local or internet using a webbrowser
- xNet (Client Server Application)

External Device Control & Support

- NAS Storage Systems
- RS232 I/O Controllability
- Supports external USB, Firewire hard drives
- Aprilaire
- Aurora Multimedia WACI IP based Products
- ELK Products
- Global Cache IP based Products
- Infinity CCTV Products
- Insteon, UPB-PCS, x10 Products
- Russound Multi-Room Audio

Media Content Management

- Audio Playback reads ID3,WMA tags
- Disk insert notification
- CD, DVD, VCD Disc Player
- CD, DVD, VCD Autoplay, Autocopy
- DVD, CD Spider System
- Internal Video player
- Music Management library
- Movie Management library, 5 categories
- Video Management library
- Media File browser
- Music Jukebox with Playlist
- Movie Jukebox with Playlist
- Music player Single or Multizone
- Picture Viewer with Slideshows
- xlobby utilizes a DirectShow based playback engine, third party filters can be downloaded to support additional audio/video formats as needed.

Supports Video File Formats, xvid, divx, avi, wmv, wmv-HD, mpg, mpeg1, mpeg2, mpeg4

- Supports Audio File Formats**, mp3, m4a, wma, wav, ogg, ape, flac
- Supports Picture Formats** jpg (jpeg), bmp, tiff, gif, png
- Supports External Media Players** Winamp, Foobar

Plugins

- Caller ID
- DVD Copy
- USB-UIRT
- XMail
- XNetflix
- XUTube
- XWeather

Remote Control Support

- Creative Labs
- Hauppauge
- x10 Remotes
- Microsoft (Media Center)
- Snapstream
- IR, RF Keyboard and Mouse
- USB & RS232 Touch Screens

Standard Interface

- Menu interfaces suitable for Remote Controls, Touchscreens, Mouse & Keyboard
- On-screen keyboard
- Time & Date Display
- Webbrowser support
- Built-in-Screen saver

Weather

- Multi-location by City & State with 5 day Forecast with detailed information and various satellite imagery

3rd Party Support

- Calendar based Event Manager
- File browser
- Internet browser
- Launch third party applications
- Girder interface

xLobby Widgets

- Send E-Mails or Text Messages based on specified system events
- Touchscreen Post-It
- CCTV, IP Video
- Audio Video Switcher
- Insteon
- Russound

Remote Service (Log-Me-In)

- Access to xLobby offsite from the internet to perform remote service, training and maintenance or to modify users systems.

xLobby Hardware Support

- Video Outputs
- Component Video, Composite Video, VGA Video, DVI \ HDMI
- Audio Outputs
- SPDIF, 44.1Khz, 48Khz, 96Khz
- Analog L+R, 5.1 digital or analog discrete
- Communication Support
- USB Ports, Firewire Ports, RS232, IP-UDP, Web Enabled Devices

Input Devices

- Ir Remote
- Ir Keyboard & Built-in pointing mouse for 8-direction cursor control
- Touchscreens (RS232, USB)

Case Styles

- Desktop, 19" 1U and up rack models available for Client and Server models

